

**Undercounter Dishwasher**

**F504-20C**

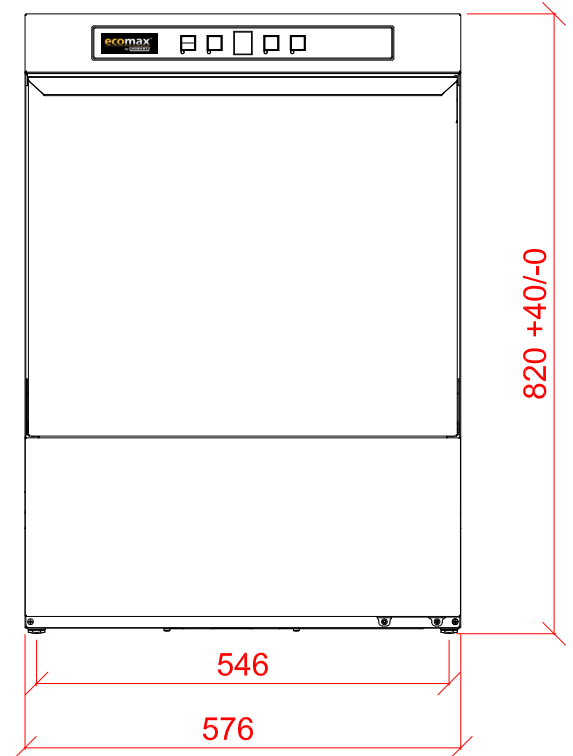
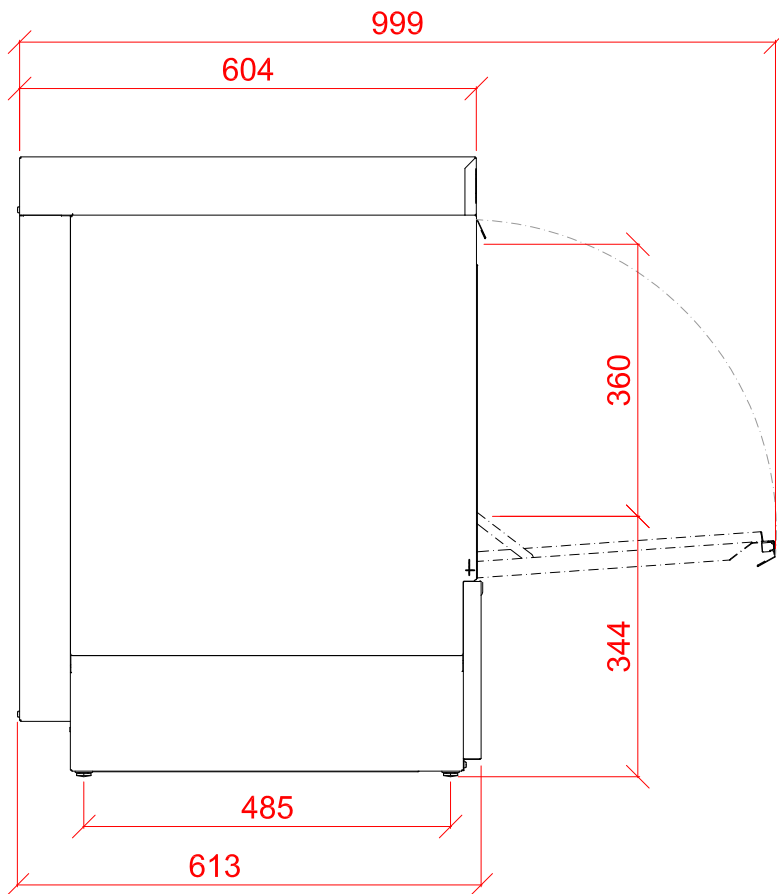
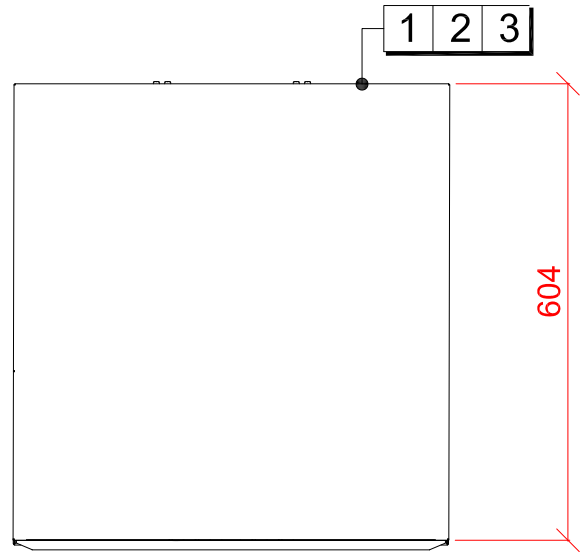

**1 Water**

22mm CONNECTION VIA 2 METRE FLEXIBLE HOSE, FEMALE TERMINATION.

WATER SUPPLY 15°C TO 65°C @ 0.8 TO 6.0 BAR MAX.  
INITIAL TANK FILL 25 LITRES.  
RINSE WATER USAGE 2.0 LITRES PER CYCLE. MAX USAGE 120 LITRES PER HOUR.  
OUR MACHINES ARE SUPPLIED WITH CLASS 'AB' AIR GAP AS STANDARD.

**2 Drain**

DRAIN: 2.0 METRE FLEXIBLE HOSE TO A 40mm TRAPPED STANDPIPE  
650mm MAX A.F.F.L.

FLOW RATE 30 LITRES PER MINUTE.

**Other Services**

RINSE AGENT HOSE - 2.5 METRE FLEXIBLE.  
DETERGENT HOSE - 2.5 METRE FLEXIBLE.

**3 Electric**

4.1kW 230/50/1 FUSED AT: 1 x 20amps.  
CONFIGURABLE TO:  
5.9kw 400/50/3 FUSED AT: 3 x 16amps  
2.2kW 230/50/1 FUSED AT: 1 x 13 amps  
MACHINE SUPPLIED WITH 2.0 METRES OF CABLE

**Notes**

+40mm ADJUSTMENT FOR FEET  
NET WEIGHT 46kg.

**PLOT SCALE: 1:10**

RIGHT TO MAKE NECESSARY CHANGES IS RESERVED